

REMOVING EXISTING BALLAST

- A.) **DISCONNECT POWER TO FIXTURE**
- B.) Remove existing fluorescent tubes and properly recycle.
- C.) Locate the existing ballast inside the fixture
- D.) Cut existing wires from ballast to fixture and ballast to power. (Cut wires near ballast to ensure proper length).
- E.) Remove ballast and properly recycle.

INSTALLING LED LAMPS (see wiring diagram on Pg. 2)

- A.) Reconnect existing wires directly to the power source.
- B.) Reassemble ballast cover.
- C.) Insert Neptun LED T8 Lamps into existing sockets.
- D.) Resupply power to fixture.

1. Remove Electronic Ballast



2. Connect Wiring

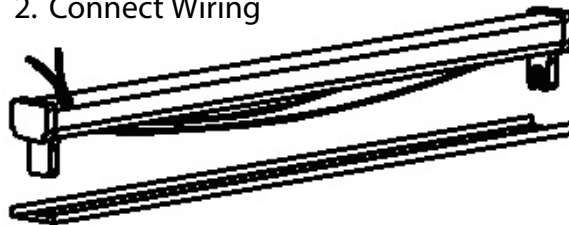

3. Install LED Tube

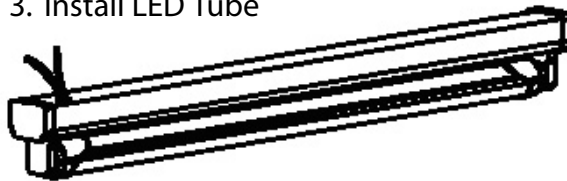

NOTE:

Neptun LED Tubes are suitable for non-shunted Rapid Start Sockets



NON-SHUNTED

VS.



SHUNTED

CAUTION!

DISCONNECT POWER SUPPLY BEFORE INSTALLATION OR MAINTENANCE.
 INSTALLATION OF THIS PRODUCT SHOULD BE DONE BY A FULLY QUALIFIED AND
 LICENSED ELECTRICIAN OR TECHNICIAN.

Wiring Diagram: U.S. Instant Start 1 Lamp System

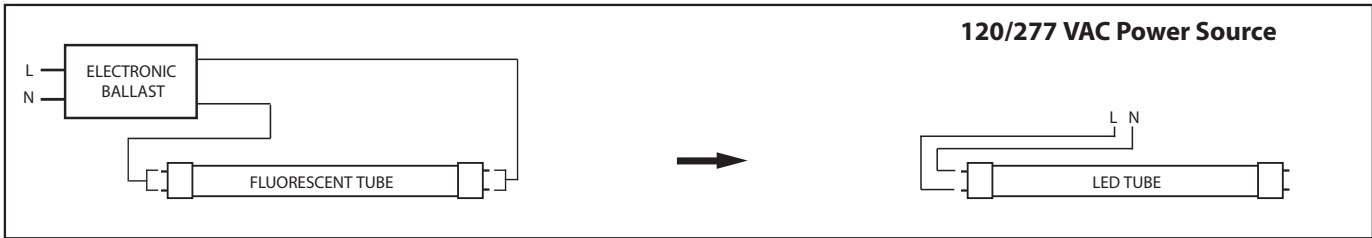

Wiring Diagram: LED Retrofit

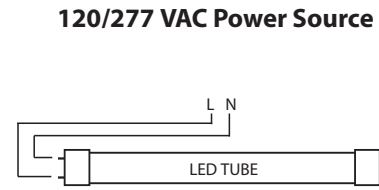

Wiring Diagram: U.S. Instant Start 2 Lamp System

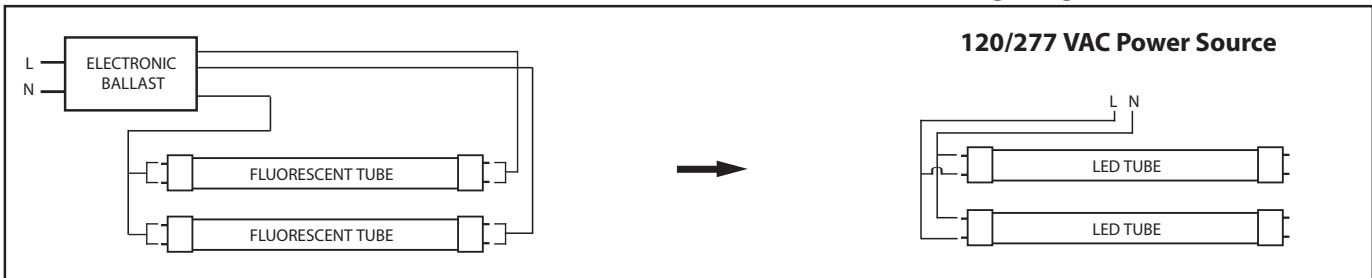

Wiring Diagram: LED Retrofit

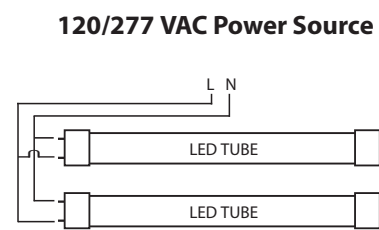

Wiring Diagram: U.S. Instant Start 3 Lamp System

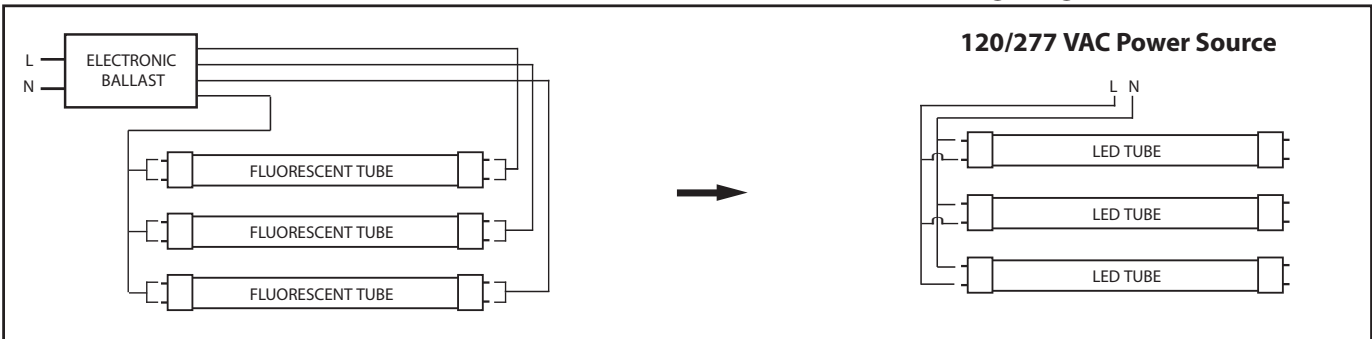

Wiring Diagram: LED Retrofit

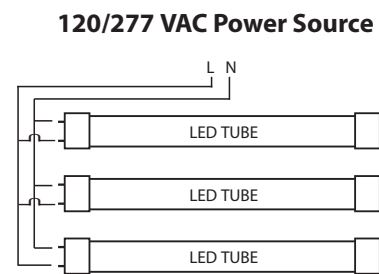

Wiring Diagram: U.S. Instant Start 4 Lamp System

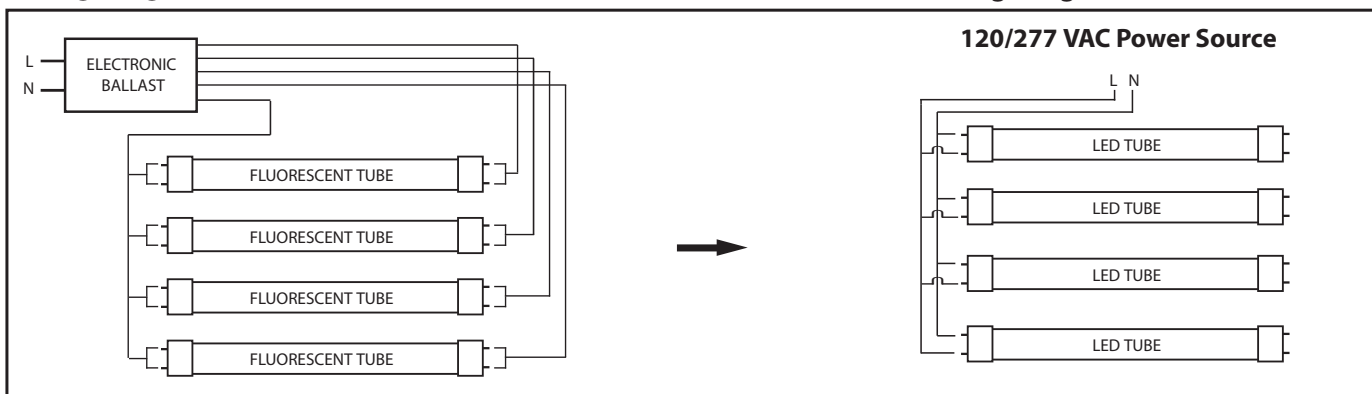

Wiring Diagram: LED Retrofit

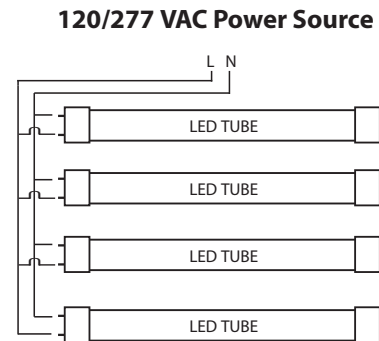

CAUTION!

DISCONNECT POWER SUPPLY BEFORE INSTALLATION OR MAINTENANCE.
 INSTALLATION OF THIS PRODUCT SHOULD BE DONE BY A FULLY QUALIFIED AND
 LICENSED ELECTRICIAN OR TECHNICIAN.